

Autonomous Cruise Control of Circulating Multi-Robot for Congestion

Satoshi Hoshino, Hiroya Seki, Yuji Naka, and Jun Ota

Abstract—This paper describes a methodology regarding an autonomous cruise control (ACC) of circulating multi-robot which is directly effective for solving the congestion regardless of the presence of a bottleneck. For this purpose, we focus on an external interaction force between the robots. This force is generated with the use of a virtual damper. In this methodology, two control scenarios are presented: a damping force acts on a moving robot as the external interaction force, (I) only when its preceding robot(s) is/are stopping or being congested and (II) when a robot exists in front of the moving robot, in order not to become involved in the congestion. This paper deals with a circuit and a robotic manufacturing-transportation system for industrial automation. Through simulation experiments, it is shown that the proposed ACC successfully solves the congestion, and finally, improves the throughput. In addition, the superiority of the two control scenarios, ACCs (I) and (II), is discussed.

I. INTRODUCTION

According to the theory of constraints (TOC), a localized bottleneck is a constraint that dominates the entire system performance. In a system with mobile objects, the bottleneck sometimes induces congestion of them. Even in a system in which a bottleneck does not exist, the same congestion takes place. Eventually, the congestion has a harmful effect on the flow of the mobile objects, i.e., the system performance.

When self-driven particles capable of determining their own actions, such as cars and mobile robots, travel in the same direction, even if there is no bottleneck (e.g., a signal), the particles aggregate, causing the congestion of mobile objects. After that, the congestion extends and moves in the opposite direction of the traveling flow. This phenomenon has been mathematically proven and formulated [1] [2]; then, experimental evidence, which is the emergence of the phenomenon with no bottleneck on a circuit, has been presented [3].

In manufacturing-transportation systems with industrial robots, material-handling robots transport materials between work stations. In the system, therefore, a work station might be a bottleneck; the congestion takes place due to an operational delay resulting from the localized bottleneck. This is because the robots join the tail of the congestion at short intervals, i.e., they queue, while the robot in front leaves the work station bit by bit. In consequence, the queue is extended in the opposite direction of the bottleneck.

Since a performance deterioration due to the congestion is the most obvious on a cyclic layout structure, this paper deals with a circuit and a manufacturing-transportation system that

have this layout structure. The former contains no bottleneck and the latter includes work stations as a bottleneck. As for the system performance, we focus on the throughput as an index. Therefore, regardless of the presence of a bottleneck, we tackle the following problem as a research challenge: the throughput not only fails to increase but also may become worse due to the congestion, i.e., a queue develops even if more robots (mobile objects) are used.

For this challenge, recently, a multi-robot coordination approach based on centralized [4] and decentralized [5] controllers has allowed each robot to avoid congested regions and move towards less congested regions. In addition, we have proposed route planning and task assignment techniques for an industrial system in which robots have to move on fixed lanes [6]. However, these are indirect approaches to solve the congestion.

On the other hand, in our approach to the challenge, circulating robots move towards the congestion and are not allowed to avoid it located anteriorly. Therefore, we propose a methodology regarding an autonomous cruise control (ACC) of the circulating multi-robot which is directly effective for solving the congestion. In this methodology, two control scenarios are presented in order not to become involved in the congestion. Through simulation experiments, it is shown that the proposed ACC successfully solves the congestion, and finally, improves the throughput. In addition, the superiority of the two control scenarios is discussed.

II. RELATED AND PREVIOUS WORKS

Autonomous intelligent cruise control systems (AICCSs) have been developed to adjust a vehicle's velocity to that of a preceding vehicle and keep it at a safe distance. A control law for the AICCS based on a constant time headway safety distance has been proposed [7]. In this system, autonomous vehicles successfully followed the preceding vehicles while avoiding collisions. However, the vehicle was not allowed to control its velocity with respect to the preceding vehicle or congestion outside of a given control area.

Shock waves, i.e., stop-and-go motions of cars have been regarded as a reason of the traffic congestion formation. A new continuum traffic flow model and the formation and structure of vehicle clusters in the Payne-Whitham traffic flow model have been proposed [8] [9]. In order to prevent the backward transmission of the influence of the velocity fluctuation, previous models have largely focused on solving the congestion by forming a cluster which consists of vehicles. However, the optimal cluster size and its interval have not been taken into account. For this reason, it has not been discussed if the throughput was increased by solving the congestion.

S. Hoshino, H. Seki, and Y. Naka are with the Chemical Resources Laboratory, Tokyo Institute of Technology, Yokohama, Kanagawa 226-8503, JAPAN hosino@pse.res.titech.ac.jp

J. Ota is with Research into Artifacts, Center for Engineering (RACE), The University of Tokyo, Kashiwa, Chiba 113-8656, JAPAN

We have thus far controlled the robot behavior based on the positional information. **Fig.1** shows the forward control area of the robot that was used for behavior control. The robot is allowed to determine its velocity by accelerating or decelerating on the basis of the control area. For a robot to ensure collision avoidance, the minimum safety distance area is provided regardless of the velocity. In addition, each robot has another control area, i.e., the stopping distance, which includes response and braking distances outside of the minimum safe distance. The range of this area changes as follows: $vt + \frac{v^2}{2a}$, where v , t , and a represent the velocity, response time, and maximum braking rate, respectively.

On the basis of the relative position, the robot moves while switching the following three control modes: 1) maximum deceleration; 2) deceleration; and 3) maximum acceleration or constant. A robot (R 1) that is moving behind another one switches the control mode to 1 if the preceding robot (R 2) is inside the minimum safe distance; to 2 if the preceding robot (R 3) is within the minimum safe distance plus the stopping distance, that is, the objective control area, in order to stop the minimum safe distance short of R 3; and to 3 within the limiting velocity if the preceding robot (R 4) is outside of the objective control area, as shown in **Fig.1**.

However, as well as [7], a robot that is following another one is not allowed to reduce its velocity for the preceding robot outside the objective control area. Consequently, a stopping robot is gradually taken into the objective control area of a moving robot; finally, the moving robot also has to stop after switching the control modes, i.e., $3 \rightarrow 2 \rightarrow 1$. The continuous phenomenon causes and expands the congestion of the robots.

III. PROPOSED AUTONOMOUS CRUISE CONTROL

A. Idea of the ACC

The key idea to directly solve the congestion of robots is that, when congestion occurs, a robot moving toward the congestion with control mode 3 has to avoid becoming ensnared in it. For this purpose, we introduce an external interaction force in order for the robot to reduce the velocity.

In related studies on robot or vehicular control using an external force, Arai *et al.* proposed a virtual impedance method. Multiple mobile robots accomplished a real-time plan to follow a generated trajectory while avoiding obstacles and avoiding or cooperating with other robots [10] [11]. Similarly, impedance control methods for a vehicle platoon system [12] and the behavior control of a vehicle using a virtual spring and damper in order to follow the preceding

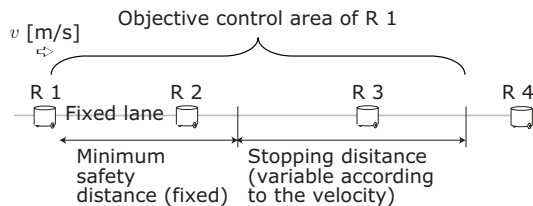

Fig. 1. Forward Control Area of the Robot (Moving Towards the Right)

vehicle [13] have been proposed. These methods, however, have focused on a position control that is based on an external force, i.e., impedance for collision avoidance and following objects used by robots, vehicles, and obstacles, rather than on congestion. Therefore, the control area was limited to that around the objects.

On the other hand, the proposed ACC allows the moving robot with control mode 3 to reduce its velocity for the preceding robot that is stopping outside of the objective control area so that the robot keeps the relative position, namely, the inter-robot distance with the stopping robot. This is done by removing the objective control area for the meantime, inserting a virtual damper in between, and exerting a damping force on the moving robot. As the other control scenario, not only for the stopping robot, but also for the preceding moving robot, the virtual damper is inserted in between and the damping force is exerted. It is to be noted that, since the robot moves on fixed lanes and aims to control only the longitudinal velocity using the damping force, a spring is not used.

B. External Interaction Force Using a Virtual Damper

In this paper, the following two control scenarios are presented: a damping force acts on a moving robot as the external interaction force, (I) only when its preceding robot(s) is/are stopping or being congested and (II) when a robot exists in front of the moving robot before a destination, in order not to become involved in the congestion.

Fig.2 shows an external interaction force generated with the use of ACC (I). At a given time, t , when a robot (R 2) stops outside of the objective control area on the route of a robot (R 1 moving towards right side), a virtual damper is inserted between the two robots (see **Fig.2(a)**). As a result, the velocity of R 1 after a derivative time Δt , i.e., $v_{R1}(t + \Delta t)$, is reduced by the product of the damping force and derivative time, $Dv_{R1}(t)\Delta t$, where D denotes the stickiness factor of the virtual damper and $v_{R1}(t)$ is the current velocity of the moving robot, R 1 (see **Fig.2(b)**).

Fig.3 shows that an external interaction force is acting on the robot when ACC (II) is applied. Regardless of whether the congestion takes place, in other words, even if the

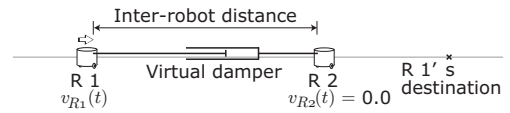

(a) Virtual damper inserted between moving and stopping robots at a given time t

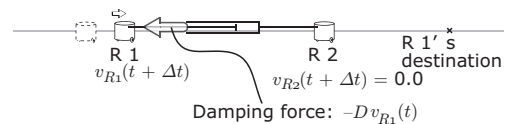

(b) Damping force acting on the following robot during a derivative time Δt

Fig. 2. ACC (I)

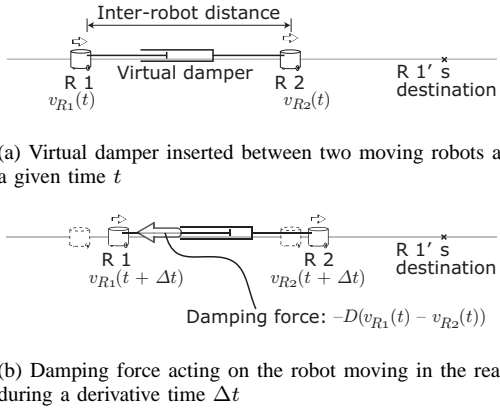

Fig. 3. ACC (II)

preceding robot outside of the objective control area is not stopping, the robot moving in the rear is constantly affected by the damping force. In this regard, however, the damping force does not act on the moving robot, and the robot moves with control mode 3 if its velocity is lower than that of the preceding robot. At a given time, t , a virtual damper is inserted between the two moving robots whenever a robot (R 2) exists in front and before a destination of the robot (R 1) (see Fig.3(a)). Therefore, the velocity of R 1 after a derivative time is reduced by $D(v_{R1}(t) - v_{R2}(t))\Delta t$, where $v_{R2}(t)$ denotes the current velocity of the preceding moving robot, R 2 (see Fig.3(b)).

C. Velocity Control with the Damping Force

When the damping force with the use of ACC (I) and ACC (II) acts on the robot, the reduced velocity of the robot after a derivative time, Δt , is expressed by (1) and (2), where a represents the acceleration of the robot, R , and R' denotes the preceding robot. We regard the derivative time Δt as the minimum sampling time for a control.

$$v_R(t + \Delta t) = v_R(t) + a\Delta t - Dv_R(t)\Delta t \quad (1)$$

$$v_R(t + \Delta t) = v_R(t) + a\Delta t - D(v_R(t) - v_{R'}(t))\Delta t \quad (2)$$

Given the discrete sampling time, Δt , for a computational simulation, the right side of (1) and (2) are replaced by (3) and (4) so that the reduced velocity of the robot does not become a negative value, $v_R(t + \Delta t) \geq 0$.

$$D \leq \frac{1}{\Delta t} + \frac{a}{v_R(t)} \quad (3)$$

$$D \leq \frac{v_R(t)}{(v_R(t) - v_{R'}(t))\Delta t} + \frac{a}{v_R(t) - v_{R'}(t)} \quad (4)$$

In (3), assuming the sampling time, $\Delta t = 1.0$, and second term in the right side, $v_R(t) \gg a\Delta t$, the stickiness has to satisfy $D \leq 1.0$ regardless of the velocity. In (4), when the relative velocity becomes larger, the denominator of the right side is approximated, $v_R(t) - v_{R'}(t) \approx v_R(t)$; and thus, the stickiness has to satisfy $D \leq 1.0$. On the other hand, when the two robots move at similar velocities, the relative

velocity becomes smaller; thus, the stickiness accepts all the positive value. Therefore, the robot reduces the velocity by determining the stickiness, D , appropriately.

In this paper, for a preceding stopping robot, both of the ACCs, (I) and (II), determine the stickiness, D , based on the inter-robot distance [14]. Thus, the inserted damper gradually becomes harder or softer according to the inter-robot distance and velocity of the moving robot. For a preceding moving robot, ACC (II) deterministically gives D a fixed value. Thus, the damper becomes harder or softer depending on the relative velocity.

IV. SIMULATION EXPERIMENT

A. Circuit and Manufacturing-Transportation System

A circuit and a manufacturing-transportation system that are treated in this simulation experiment are shown in Fig.4. The length of the main lane is 30 [m] each side; the total perimeter is 120 [m]; the intermediate lane is 5.0 [m]; and the passing lane is 35 or 40 [m], respectively. The stations, 1 ~ 12, are located on the main lane at intervals of 7.5 [m]. The discharging and initial stations are placed 15 [m] apart from each other. Since the main and passing lanes are the one-way traffic, the robots mostly circulate and move in the clockwise direction.

In the circuit where a bottleneck does not exist, each robot continues circulating around the main lanes depicted by heavy lines while ignoring the stations, and the robots do not stop at the stations. Since the intermediate and passing lanes are not used, a robot is not allowed to pass the preceding robot.

In the manufacturing-transportation system, robots circulate to transport materials between the stations. At the stations, the robots are required to stop for material handling. In transporting materials, the robot additionally uses intermediate and passing lanes depending on the situation. The detailed route planning technique is described in [6]. In

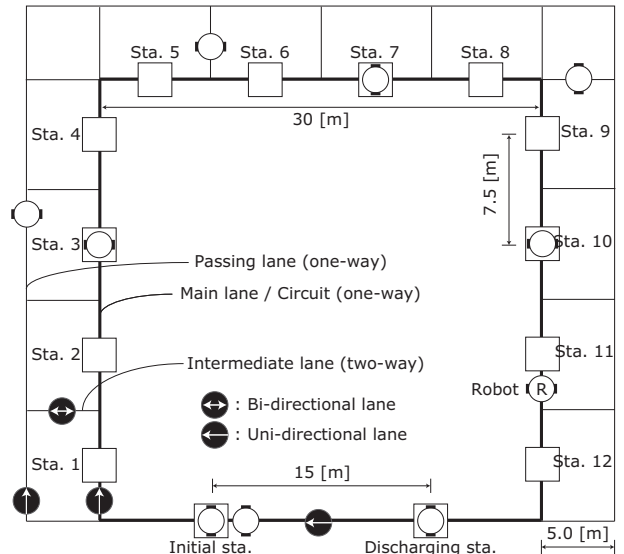

Fig. 4. Circuit and Manufacturing-Transportation System

one transport task, several stations are listed as the following sequential format: initial \rightarrow #3 \rightarrow #7 \rightarrow #9 \rightarrow #12 \rightarrow discharge. A station is listed with a certain probability. When a robot arrives at the initial station after discharging a final product, a task that equalizes the workload throughout the system is selected from unexecuted tasks and assigned to the robot by using an assignment technique [6].

We evaluate the effectiveness of the two proposed ACCs, (I) and (II), in comparison to the previous control described in II. In this regard, the stickiness of the virtual damper is given as $D = 1.0/\{\text{inter-robot distance}\}$ for the preceding stopping robot. For the preceding moving robot, the stickiness of the virtual damper is given as $D = 1.0$. The maximum acceleration of the robot is $0.05 \text{ [m/s}^2\text{]}$ ($\sim 0.7 \text{ [m/s]}$), $0.08 \text{ [m/s}^2\text{]}$ ($0.7 \sim 1.4 \text{ [m/s]}$), and $0.12 \text{ [m/s}^2\text{]}$ ($1.4 \sim 2.1 \text{ [m/s]}$), and the maximum deceleration (braking rate) is $0.2 \text{ [m/s}^2\text{]}$. The minimum safety distance for collision avoidance (see **Fig.1**) is set to 3.0 [m] .

B. Circuit Simulation

In this simulation, each robot circulates 200 times in the circuit. The number of robots is changed from 1 to 20 in each simulation. Hence, 20 robots circulate in total $200 \times 20 = 4000$ times, for instance.

Fig.5 shows the simulation result regarding the total circulating time. In the result obtained applying the proposed ACCs, when the number of robots was more than 12, the robots finished circulating earlier than they did in the result of the previous control. The reason for this result is that, by applying the previous control, the congestion of the robots emerged spontaneously at the so-called phase transition point; eventually, this worsened the total circulating time. As a result, the two proposed ACCs successfully solved the congestion and improved the throughput. In this regard, the two ACCs with robots more than 12 resulted in the different circulating time as the number of robots increased. This is because that, by using ACC (II), in the circuit crowded with the robots (i.e., after the phase transition), the robots were often affected by the preceding robots moving or stopping.

The tracks of the 20 robots in the circuit up to 1,000 seconds are shown in **Fig.6**. Since the y-axis shows a position of robots, a flat line (dots) to the simulation time step depicts that a robot is stopping. Therefore, the flat lines show the

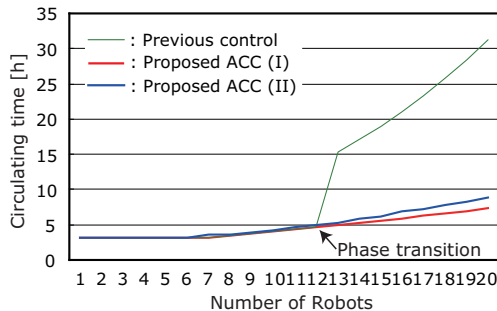

Fig. 5. Simulation Result in the Circuit

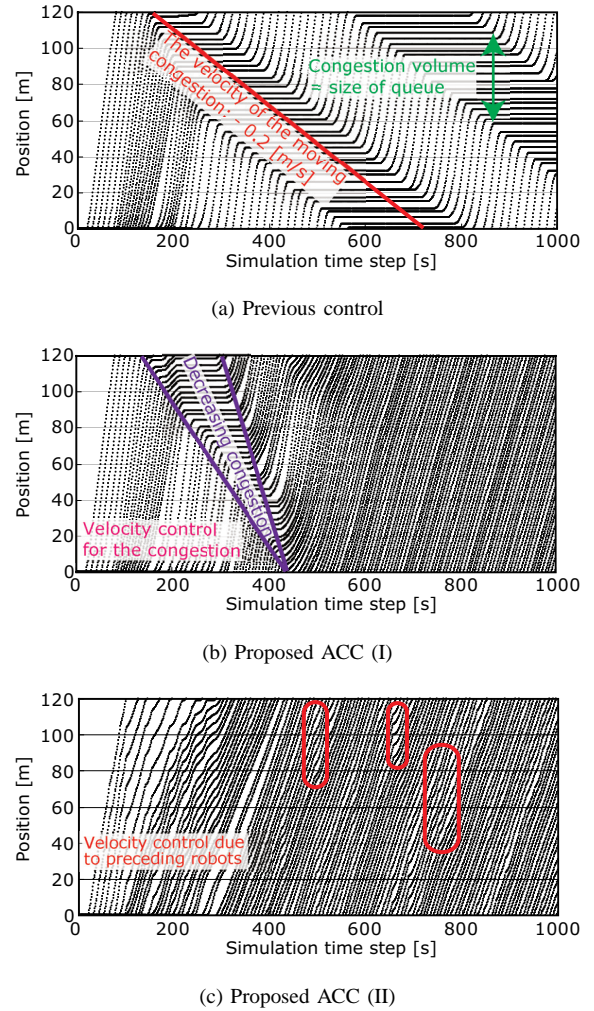

Fig. 6. Tracks of the Robots (on the Main Lanes) in the Circuit

congestion of the robots. A position of the robot that finished traveling around the circuit is reset to zero, i.e., $120 = 0 \text{ [m]}$.

The previous control resulted in the congestion of the robots around 200 seconds later as shown in **Fig. 6(a)**; then, the congestion was not solved until the end of the simulation. This is due to stop-and-go motions. The congestion, then, moved in the opposite direction at a velocity of 0.2 [m/s] while maintaining its size. In **Fig. 6(b)**, on the other hand, the proposed ACC (I) solved the congestion around 400 seconds later; after that, each robot circulated while maintaining equal intervals. **Fig. 6(c)** shows the result with the use of the ACC (II). As can be seen in this figure, the congestion was not formed. This is because the robot reduced its velocity due to not only the stopping robot but also the moving robot in front of it. In fact, deceleration behavior was sometimes observed as depicted by red circles. However, since the average velocity was lower than that of ACC (I) due to this behavior, the circulating time was lengthened as shown in **Fig.5**. The average velocities of the 20 robots were 0.21 (previous control), 0.89 (ACC (I)), and 0.75 (ACC (II)) $[\text{m/s}]$.

These results demonstrated that the proposed ACCs are

effective for solving the congestion in a circuit, that is, a system without a bottleneck.

C. Manufacturing-Transportation System Simulation

In this simulation, each station of 1 ~ 12 is listed as a destination in a transport task with a probability of 0.3, 0.6, and 0.9. When a station is listed, the required stop time for a robot at the station is determined to be 30 ~ 80 [s] with a uniform distribution in a random manner. At the discharging and initial stations, 10 ~ 40 [s] and 20 ~ 80 [s] with a uniform distribution are required in a random manner. 200 products are produced in total and the number of robots, 2 to 20, is increased by 2 in each simulation.

Fig.7 shows the result regarding the averaged operation time of five-times simulation for the same number of robots. Due to the bottleneck, the operation time was not constantly decreased as the number of robots increased. When the tasks were light, that is to say, a station was determined to be a destination with a probability of 0.3, the system with the use of the two ACCs finished the operation earlier than of the previous control as the number of robots increased, especially more than 4 robots (see **Fig. 7(a)**). For the medium tasks, while the operation time of the system with the previous control was worsened when the number of robots was more than 10, the two ACCs shortened the operation time up to 12 robots. For more than 14 robots, although the operation time was increased, it was still better than the one obtained by applying the previous control (see **Fig. 7(b)**). For the heavy tasks, except for the system with 12 robot, ACC (I) shortened the operation time compared to others (see **Fig. 7(c)**).

These results indicate that, after the congestion occurred around stations, the two ACCs were more effective than the previous control. Especially, ACC (I) improved the throughput most effectively regardless of the light, medium, or heavy tasks, i.e., the degree of a bottleneck.

D. Result Analysis

Although ACC (II) completely solved the congestion as shown in **Fig. 6(c)**, it resulted in the ineffective system compared to the system with ACC (I). To investigate the reason of these results in IV-B and IV-C, we focus on the average velocity of the robots as their behavior in the circuit and the manufacturing-transportation system.

Fig. 8 shows the average velocity of the robots in the circuit. Up to 6 robots, since the preceding robot seldom existed in the objective control area and no congestion occurred, three control techniques resulted in the same average velocities. Thus, also in **Fig.5**, the circulating times were almost the same. After that up to 12 robots, ACC (II) resulted in the lowest average velocity due to the damping force by the preceding moving robot. In **Fig.5** (6 ~ 12 robots), for this reason, the circulating time with ACC (II) was a tiny time-consuming. For more than 12 robots, the congestion was spontaneously formed due to the phase transition when the previous control was used; thus, the average velocity was drastically decreased. In contrast, the proposed ACCs, (I) and (II), solved the congestion by reducing the robots'

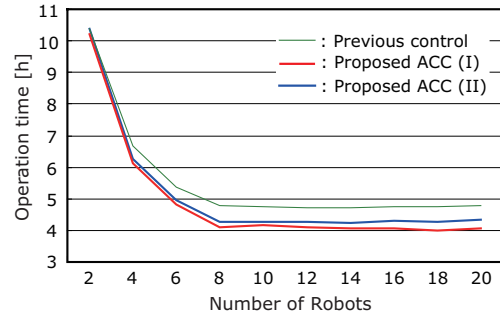

(a) Light tasks (0.3)

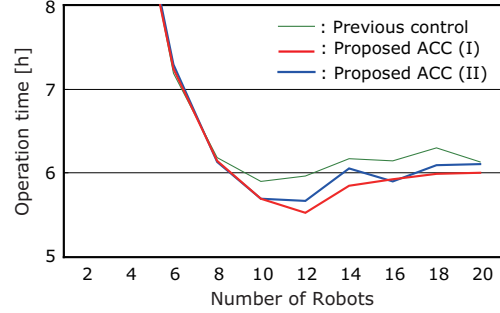

(b) Medium tasks (0.6)

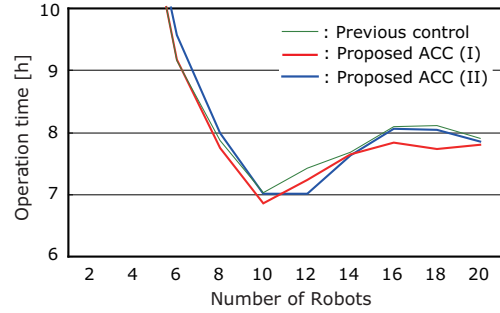

(c) Heavy tasks (0.9)

Fig. 7. Simulation Result in the Manufacturing-Transportation System

velocities, as a result, the average velocities were gradually decreased. In this regard, also, the robot constantly reduced its velocity for the preceding moving robot by using ACC (II), the average velocity was relatively lower than that of ACC (I).

Fig. 9 shows the average velocity of the robots when the results in **Fig. 7** were obtained. For the light tasks, we can see the effectiveness of ACC (I) in **Fig. 9(a)**. The average velocity was, therefore, the highest. Thus, in **Fig. 7(a)**, ACC (I) resulted in the most efficient system. Furthermore, while the average velocity with the use of ACC (II) was similar to that of previous control (see **Fig. 9(a)**), ACC (II) resulted in a more efficient system than the previous control (see **Fig. 7(a)**). For the higher degree of a bottleneck, in **Fig. 9(b)**, the average velocity with the use of ACC (I) was a slightly-high; thus, in **Fig. 7(b)**, ACC (I) resulted in the most efficient system. In **Fig. 9(c)**, finally, the three average velocities were

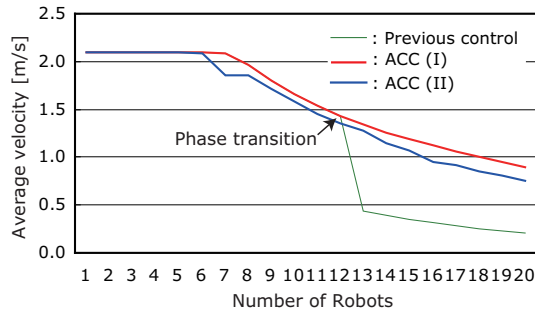
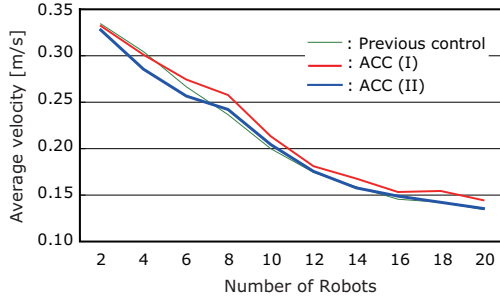
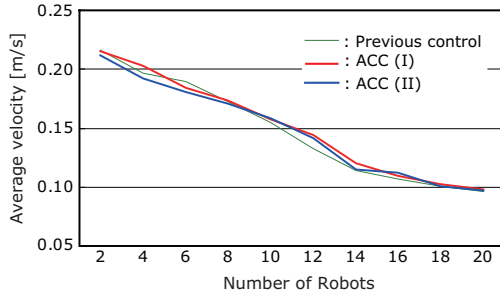

Fig. 8. Average Velocity of the Robots in the Circuit



(a) For the light tasks in Fig. 7(a)



(b) For the medium tasks in Fig. 7(b)

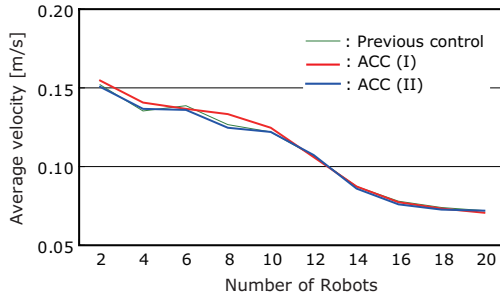

(c) For the heavy tasks in Fig. 7(c)

Fig. 9. Average Velocity in the Manufacturing-Transportation System

almost the same. Nonetheless, as a remarkable result, in **Fig. 7(c)**, ACC (I) shortened the operation time.

The reason of the results is that, in the robotic manufacturing-transportation system experiencing bottleneck, unlike the circuit where a bottleneck does not exist, since the robots have to stop at the stations, the congestion often took place around the stations. In other words, by using

ACCs (I) and (II), the robots often reduced their velocities due to the bottleneck. However, the behavior using ACC (I) successfully reduced the congestion volume around the stations and resulted in the most efficient system.

From this result, regardless of the presence of a bottleneck, we found out that an external interaction force among the robots is not necessary until the congestion takes place. Furthermore, an excessive force has the opposite effect on the velocity, and, therefore, the throughput. Therefore, after the phase transition, the robots moved at the highest velocity with the use of ACC (I).

V. CONCLUSIONS

This paper described a methodology regarding an ACC of circulating multi-robot which is directly effective for solving the congestion in a circuit and a manufacturing-transportation system. In this methodology, two control scenarios were presented. Through simulation experiments, it was shown that the proposed ACCs successfully solved the congestion, and finally, improved the throughput. By exerting a damping force on the moving robot only for the stopping or congested robot(s) in front of it, ACC (I) resulted in the most efficient system regardless of the presence of a bottleneck. The effectiveness of the ACC on the throughput seems to be not so much as expected in case of the manufacturing-transportation system. However, note that this will be more clear as the number of products is increased.

REFERENCES

- [1] B. S. Kerner *et al.*, "Cluster Effect in Initially Homogeneous Traffic Flow," *Physical Review E*, vol. 48, no. 4, pp. 2335–2338, 1993.
- [2] M. Bando *et al.*, "Dynamical Model of Traffic Congestion and Numerical Simulation," *Physical Review E*, vol. 51, no. 2, pp. 1035–1042, 1995.
- [3] Y. Sugiyama *et al.*, "Traffic Jams without Bottlenecks – Experimental Evidence for the Physical Mechanism of the Formation of a Jam," *New Journal of Physics*, vol. 10, 033001, 2008.
- [4] L. Qiu *et al.*, "Scheduling and Routing Algorithms for AGVs: A Survey," *International Journal of Production Research*, vol. 40, no. 3, pp. 745–760, 2002.
- [5] S. Maniccam, "Adaptive Decentralized Congestion Avoidance in Two-dimensional Traffic," *Physica A*, vol. 363, no. 2, pp. 512–526, 2006.
- [6] S. Hoshino *et al.*, "Pipeless Batch Plant with Operating Robots for a Multiproduct Production System," *Distributed Autonomous Robotic Systems 8*, Springer, pp. 503–512, 2008.
- [7] P. A. Ioannou *et al.*, "Autonomous Intelligent Cruise Control," *IEEE Trans. on Vehicular Technology*, vol. 42, no. 4, pp. 657–672, 1993.
- [8] R. Jiang *et al.*, "A New Continuum Model for Traffic Flow and Numerical Tests," *Transportation Research Part B*, vol. 36, no. 5, pp. 405–419, 2002.
- [9] W. L. Jin *et al.*, "The Formation and Structure of Vehicle Clusters in the Payne-Whitham Traffic Flow Model," *Transportation Research Part B*, vol. 37, no. 3, pp. 207–223, 2003.
- [10] T. Arai *et al.*, "Motion Planning of Multiple Mobile Robots Using Virtual Impedance," *Journal of Robotics and Mechatronics*, vol. 8, no. 1, pp. 67–74, 1996.
- [11] T. Arai *et al.*, "Dwarf Intelligence – A Large Object Carried by Seven Dwarves," *Robotics and Autonomous Systems*, vol. 18, no. 1–2, pp. 149–155, 1996.
- [12] S.-Y. Yi *et al.*, "Impedance Control for a Vehicle Platoon System," *Mechatronics*, vol. 15, no. 5, pp. 627–638, 2005.
- [13] A. Gorjestani *et al.*, "Impedance Control for Truck Collision Avoidance," in *American Control Conference*, pp. 1519–1524, 2000.
- [14] S. Hoshino *et al.*, "Behavior Control Methodology for Circulating Robots in Flexible Batch Manufacturing Systems Experiencing Bottlenecks," *IEEE/RSJ International Conference on Intelligent Robots and Systems*, pp. 5350–5356, 2009.